



PRODUCT CATALOG

UPDATED 10/2025

SOLUTIONS FOR INTEGRATION PROFESSIONALS

RESIDENTIAL | COMMERCIAL | HOSPITALITY

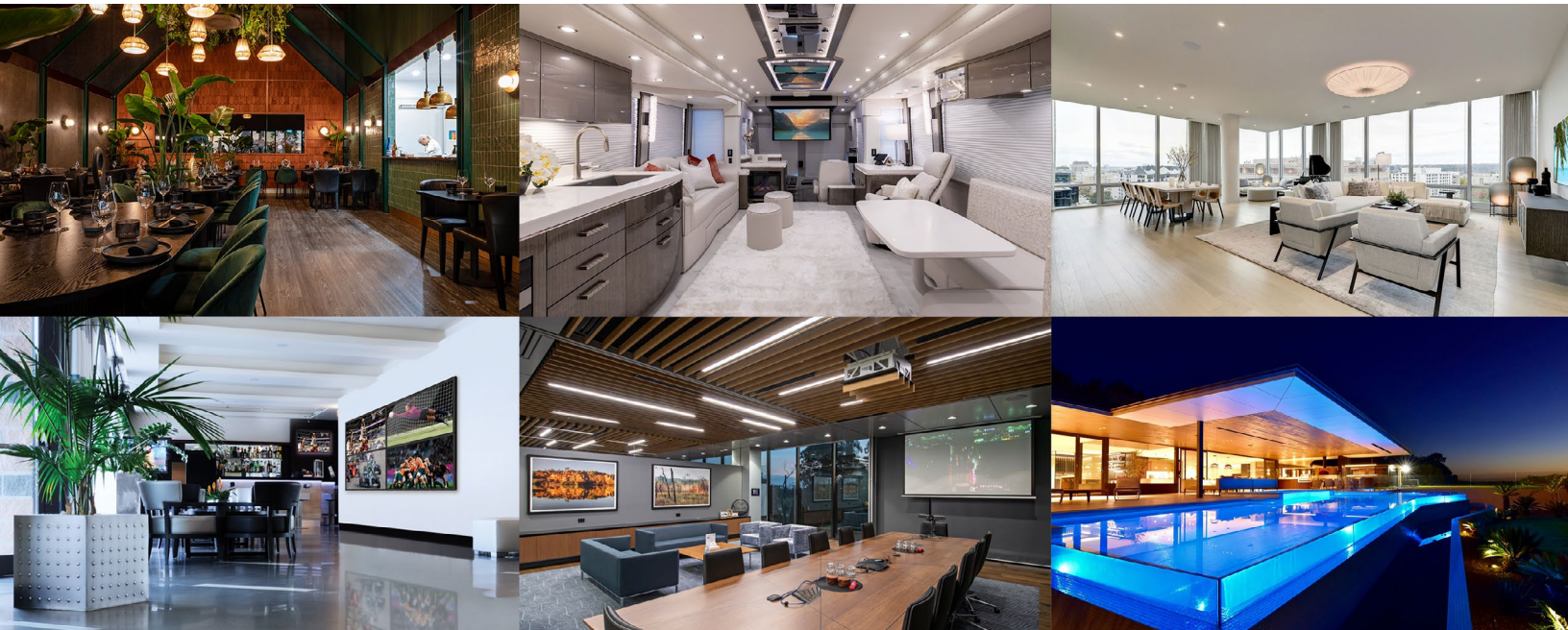

When was the last time you fell in love with a remote?





Table of Contents

Control Processors	4
Intelligent Surfaces - Remotes.....	8
Intelligent Surfaces - Touchpanels.....	13
Intelligent Surfaces - Keypads	18
Custom Engraving.....	20
Audio Distribution.....	22
Accessories - Control Modules.....	26
Accessories - Receivers & Antennas	29
Accessories - Power Supplies	30
Accessories - Dealer Tools	31

Contact Information

AVPro Global Holdings, LLC
2222 E 52nd Street N
Sioux Falls, SD 57104
www.rticontrol.com

Telephone: 877-886-5112
Telephone International: +1-605-274-6055
Orders: orders@avproglobal.com
Technical Support: RTISupport@avproglobal.com

Training: Choose Your Own Path

- **Weekly Online Associate Level Integration Designer Training**
Learn the fundamentals of RTI programming, configuration, and system design.
- **Integration Designer On-Demand Training**
Recorded, multi-course webinar—learn at your own pace.
- **3-Day In-Person Integration Designer Expert Training**
Hands-on training with a full rack of gear. The course concludes with a project exam and certification

[Learn more about RTI's training options](#)

Warranty

NOTE: For complete warranty information please consult the product page on the RTI website.

AVPro Global Holdings, LLC warrants RTI products for a period of three (3) years from the date of purchase from an authorized AVPro Global Holdings, LLC distributor or dealer. Rechargeable batteries and B-Stock products carry a one (1) year warranty. Warranties apply only to those products sold through authorized AVPro dealers. Any product found to be defective can be exchanged at an authorized AVPro distributor or AVPro directly within 90 days of purchase. After 90 days, all products must be returned to AVPro for repair, after receiving a Return Authorization from the AVPro Order Desk (see email above).

Service:

RTI products not covered by warranty can be repaired for a fee by obtaining a Return Authorization number from the AVPro Order Desk. The Return Authorization number should be referenced on the shipping carton and a copy of the Return Authorization form should accompany the product in the shipping carton. Products returned for service may be repaired or replaced at AVPro's discretion.

Disclaimer and Copyright Information

- All rights are reserved. No part of this document may be photocopied, reproduced, or translated without the prior written notice of AVPro Global Holdings, LLC.
- The information contained in this document is subject to change without notice. AVPro Global Holdings, LLC shall not be liable for errors or omissions contained herein or for consequential damages in connection with the furnishing, performance, or use of this product reference guide.
- Windows is a registered trademark of Microsoft Corporation in the United States and other countries.
- Zigbee is a registered trademark of the Zigbee Alliance.
- Z-Wave is a registered trademark of Sigma Designs Inc.
- Apple, iPod touch, iPhone and iPad are registered trademarks of Apple Inc.
- Android and Google Play are registered trademarks of Google Inc.
- Integration Designer and the RTI logo are registered trademarks of AVPro Global Holdings, LLC.
- Other brands and their products are trademarks or registered trademarks of their respective holders.

XP-8v Control Processor



The XP-8v is our most powerful system processor for control and automation of the most advanced smart homes, smart offices, and hospitality environments. XP-8v delivers maximum processing power, with an expanded number of inputs and outputs, including an HDMI® output to enable an on-screen display (OSD) interface.

Control is delivered via IP, RS-232, infrared, relays, and sensing to support the entire RTI ecosystem and connected subsystems, allowing for easy expansion using multiple processors and a complete line of accessory devices.

Key Features

- Powerful 32bit, 1GHz CPU and 512Mb of non-volatile Flash memory.
- HDMI® output for OSD provides bidirectional control interface on a TV.
- Eight multi-purpose I/O ports for infrared and RTI modules for power sensing and one-way RS-232.
- Ethernet port allows two-way control via IP and RTIPanel support.
- Eight dedicated RS-232 ports allow bi-directional control.
- Eight programmable relays may be programmed for contact or voltage trigger.
- Eight sense inputs allow events to be triggered from either a contact closure or voltage trigger.
- Compatible with RTI ZM-24 2.4GHz Zigbee® Transceiver Module, RM-433 Antenna Module and wired user interfaces.
- USB and Ethernet programming.

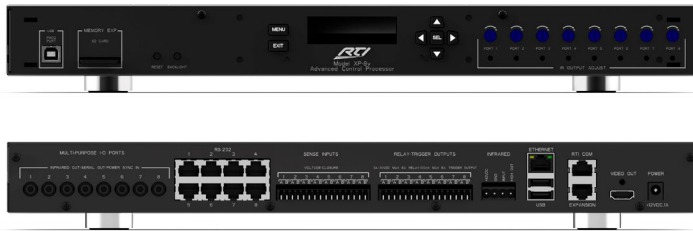

Part #: 10-210618-19

Included in the Box:

XP-8v, power supply (12V, 1A), RJ45 to DB9 serial adaptor (8), rack ears (2) with screws, feet (4) with screws, terminal blocks (3x 4-position, 3x 2-position)

Specifications

Power Supply	+12VDC, 1A
Multi-Purpose Output Ports	Eight custom 3.5mm 4-conductor jacks. Designed for RTI modules as well as industry-standard IR emitters.
IR Output Drive	100mA maximum (per port, adjustable) 200mA maximum (high IR output port)
Infrared Frequency Transmission Range.....	15kHz - 460kHz
Infrared Input.....	Compatible with industry-standard repeaters and receivers
Video Output for OSD.....	HDMI® 720p/1080p
Relays	Eight, 3 Amps @ 30 VDC or 12V/100mA Trigger
Sense Inputs.....	Eight, Digital/Closure
RS-232 Ports.....	Eight, RJ45 Connection
Ethernet Port.....	One 10/100Base-T, RJ45 Connection
USB Ports.....	Two Host, 1 Programming
RTI Com Port	Two-way Zigbee® Communication Port, RJ45 Connection
Expansion Port.....	One RS-485 / IR / PWR, RJ45 Connection
Memory Expansion	SD/MM Card Slot
Display.....	High-contrast STN LCD
Display Size (H x W)	0.7" x 2.8" (18 mm x 60 mm)
Backlights.....	32h x 122w pixels
Mounting	Blue LED (Display/Keypad)
Dimensions (W x H x D).....	17" x 1.7" x 6.4"
Weight	432 mm x 43 mm x 162 mm 4 lb. (1814 g)

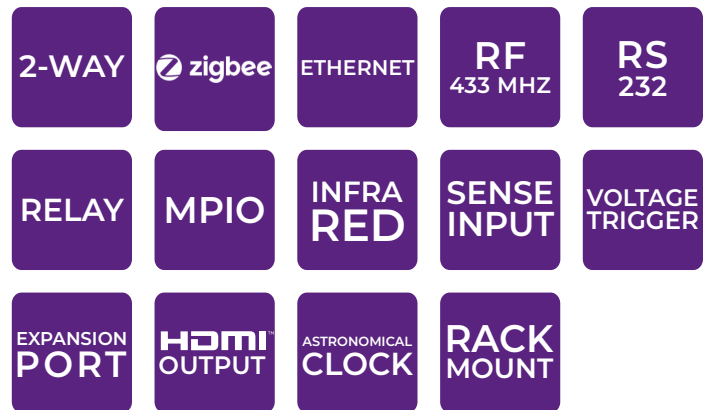

Back Panel

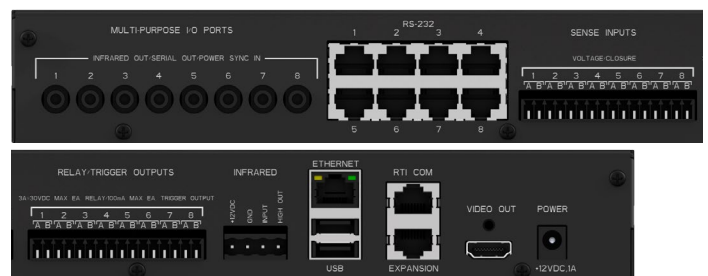

XP-6s Control Processor



The XP-6s control processor is the perfect centerpiece of any professionally installed control and automation system.

Control is delivered via IP, RS-232, infrared, relays, and sensing to support the entire RTI ecosystem and connected subsystems, allowing for easy expansion when using multiple processors and our line of accessory devices. With a rack-mountable design, the XP-6s has the processing power to deliver exceptional performance for smart home and smart business systems.

Key Features

- Powerful 32bit, 1GHz CPU and 512Mb of non-volatile Flash memory.
- Six multi-purpose I/O ports for infrared and RTI accessory modules for power sensing and one-way RS-232.
- Ethernet support for two-way control and RTIPanel support.
- Three programmable 12VDC trigger outputs.
- Three assignable voltage sense inputs and three programmable relay outputs.
- Three RS-232 ports for bi-directional communication.
- Built-in astronomical clock for time-based events and sleep timers.
- Compatible with all RTI wireless interfaces (when used with RTI RF antennas/Zigbee® transceivers) and wired user interfaces.
- Inputs for connection of multiple 433MHz RF receiver modules and one ZM-24 2.4GHz Transceiver.
- USB 2.0 and Ethernet programming.

Part #: 10-210621-13

Included in the Box:

XP-6s, power supply (12V, 1A), RJ45 to DB9 serial adaptor (3), screws & drywall anchors (4), terminal blocks (3x 4-position, 3x 2-position), rack ears (2)

2-WAY	zigbee	ETHERNET	RF 433 MHZ	RS 232
RELAY	MPIO	INFRA RED	SENSE INPUT	VOLTAGE TRIGGER
EXPANSION PORT	ASTRONOMICAL CLOCK	RACK MOUNT		

Specifications

Power Supply	+12V DC, 1A
IR Output Ports.....	Six 3.5mm jacks
.....Compatible with industry standard IR emitters	
IR Output Drive.....	100mA maximum (per port, adjustable)
.....	200mA maximum (high IR output port)
Infrared Frequency Transmission Range.....	15kHz - 460kHz
Infrared Input	Compatible with industry-standard
.....	repeaters and receivers
Trigger Outputs.....	Three, 12 VDC, 100mA
Relays	Three, 3 Amps @ 30 VDC
Sense Inputs	Three, 3-24VDC
RS-232 Ports	Three, Bi-directional RJ45 Connections
Ethernet Port	10/100Base-T, RJ45 Connection
USB Ports	One, Programming
RTI Com Port.....	Zigbee® Communication Port,
.....	RJ45 Connection
Mounting.....	Rack-mount or free standing
Dimensions (W x H x D).....	8.5" x 1.72" x 6"
.....	215.9mm x 43.7 mm x 152.4 mm
Weight	2 lb. (907 g)

Front Panel



Back Panel



XP-3 Control Processor



Part #: 10-210443-15

Included in the Box:

XP-3, power supply (12V, 1A), RJ45 to DB9 serial adaptor, antenna, mounting plate, screws & drywall anchors (4)

Specifications

Power Supply	+12V DC, 1A or PoE (802.3af)
Wireless Networking	IEEE802.15.4. Zigbee® network compliant
RF Frequency Range	2.4Ghz - 2.5Ghz
Multi-Purpose Output Port (Port 1)	One custom 3.5mm, 4-conductor jack.
.....	Designed for RTI modules as well as industry-standard IR emitters.
IR Output Ports (Ports 2 & 3)	Two, 3.5mm jacks.
.....	Compatible with industry standard IR emitters
IR Output Drive	100mA maximum (per port, adjustable)
Infrared Frequency Transmission Range.....	15kHz - 460kHz
RS-232 Port.....	One, Bi-directional, RJ45 Connection
Ethernet Port.....	One, 10/100Base-T with Power-over-Ethernet (Class 3)
Relays	Two, 5 Amps @ 30 VDC or 12V/100mA Trigger
Sense Inputs.....	Two, 3-24VDC. Off/Low Voltage
.....	condition must not exceed 1VDC
USB Ports.....	One, Programming
Mounting	Wall-mount or free standing
Dimensions (W x H x D).....	7.0" x 3.0" x 1.0" (177 mm x 76 mm x 25 mm)
Weight.....	6.4 oz. (100 g)

The XP-3 is ideal for media rooms, bedrooms, meeting rooms and other small projects, delivering an exceptional level of control and automation in a small form factor. When paired with an RTI Remote, Touchpanel, or the RTI control app running on a mobile device, the XP-3 provides 2-way control for two-way real time feedback from connected 3rd party devices such as music streamers, cable boxes, lighting systems, security, and more.

Programming easily with Integration Designer, the XP-3 enables control via Ethernet, Zigbee, RS-232, IR, and relays. Its built-in astronomical clock allows for scheduling time-based events and automations.

Key Features

- Powerful 32bit, 533MHz CPU and 128MB of non-volatile Flash memory.
- One multi-purpose I/O port and two IR output ports with variable output.
- Two assignable voltage sense inputs, and two programmable relay outputs.
- One two-way RS-232 port for 2-way communication.
- Integrated 10/100Base-T Ethernet port for programming, control and 2-way communication and supports Power over Ethernet.
- Built-in astronomical clock for time-based events and sleep timers.
- Built-in 2.4GHz ZigBee® RF transceiver module and removable antenna.

RP-4 Control Processor



Part #: 10-210520-11

Included in the Box:

RP-4, power supply (12V, 1A), antenna, mounting plate, screws and drywall anchors (4)

Specifications

Power Supply	+12VDC, 1A
RF Receiver Carrier Frequency	433 MHz
Infrared Transmission Bandwidth	15kHz - 460kHz
IR Output Ports	Four (4), 3.5mm jacks
IR Output Drive	100mA maximum (per port, adjustable)
Ethernet Port.....	One, RJ45 Connection, 10/100Base-T
Relays	Two, +30VDC, 5A max
Sense Inputs.....	Two, 3-24VDC
Mounting	Wall-mount or free standing
Dimensions (W x H x D).....	7.0" x 3.0" x 1.0"
.....	175 mm x 76 mm x 25 mm
.....	(Dimension does not include antenna or connectors)
Weight.....	6.7 oz. (190 g)

The RP-4 is an excellent solution for cost-effective control in single room installations such as home theaters, media centers, and bedrooms.

The RP-4 features an integrated 433-MHz RF receiver, IR control, voltage sense inputs, and relays, all in one compact package. Perfect for use with any RTI 433-MHz wireless interface, the processor also supports one-way control via the RTiPanel app, allowing users to incorporate their iPhones and iPads easily into the control system.

Key Features

- Four infrared ports with routing and output strength adjustment.
- Infrared ports compatible with industry standard IR emitters and IR expansion devices.
- Two voltage sensing inputs for monitoring equipment power status.
- Two programmable relays provide contact closure for TV lifts, shades, projection screens etc.
- Integrated 433MHz RF antenna.
- Supports RTiPanel App for one-way control via smart phones and tablets.
- Works with all RTI 433MHz wireless remotes.
- RF signal reception and Ethernet activity LEDs.
- Install free-standing or wall mount using included mounting bracket.
- USB and Ethernet programming.

INTELLIGENT SURFACES™

REMOTES





ISR-4 Intelligent Surface Remote Control with WiFi and IR

Experience unmatched entertainment and control convenience

When was the last time you fell in love with a remote? That time is now. Meet the ISR-4 Intelligent Surface Remote. The ISR-4 elevates every interaction, whether at home or in the executive boardroom. Its best-in-class 4" diagonal high-resolution touchscreen enables easy swiping or tapping on a fully customizable interface, while its control wheel and transport keys offer tactile convenience. With an aluminum body and luxury styling, the ISR-4 is designed for both comfort and sophistication.

Key Features

- Flush-mount, 4.0" high-resolution capacitive LCD touchscreen (480x800).
- Wi-Fi control and program updates.
- Accelerometer provides "instant-on" control.
- Twenty assignable/programmable keypad buttons for commonly used functions.
- 2 individually illuminated programmable capacitive buttons on the touchscreen.
- Cursor button allows simple scrolling list navigation.
- Extremely wide IR transmitting frequency range.
- Non-volatile Flash memory stores your system configuration even when power is not present.

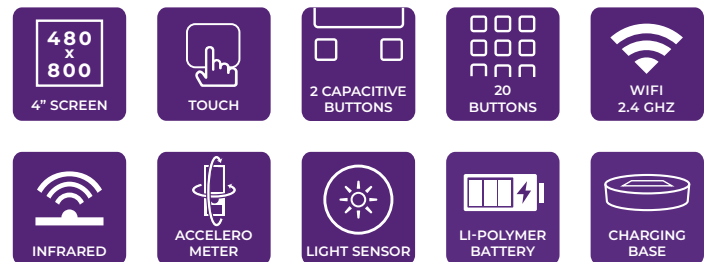

Part #: 10-210844-20
Included in the Box:
ISR-4, ISR-SB charging
base, power supply
(5V, 2A)

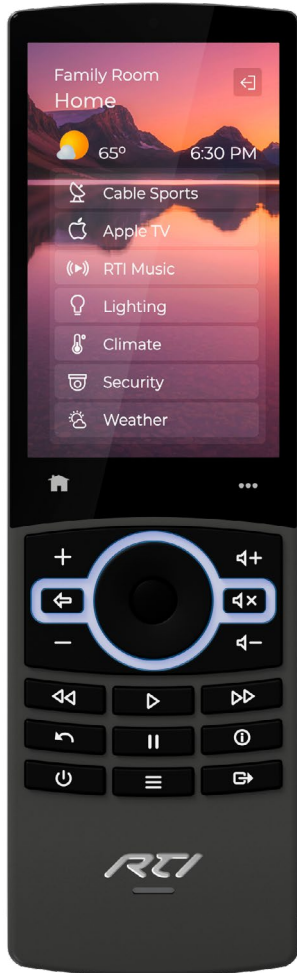

Specifications

Power	3.85 VDC, 1800 mAh Lithium-Ion Battery Pack
Power Management	Integrated accelerometer
Infrared Control Range	30 feet (9.1 meters) @ 60 degrees
Infrared Frequency Transmission Range	15kHz - 460kHz
Radio Frequency Control Range	Up to 100 feet (30.5 meters)
Wireless Ethernet	802.11b/g/n @ 2.4Ghz
Touchscreen Display	High-brightness color IPS-TFT LCD.
.....	480 x 800 pixels with 16.7M colors.
.....	Integrated high-resolution capacitive touchscreen
Display Size	4" (101mm) diagonal
Backlights	White LED (keypad & soft buttons)
Standby Time on Full Charge	7 Days
Battery Charge Time	3-4 Hours
Dimensions (L x W x D)	8.1" x 2.5" x 0.8"
.....	206 mm x 65 mm x 20 mm
Enclosure	Aluminum and molded ABS plastic
Weight ISR-4	7.55 oz. (214 g) with battery pack
Weight ISR-SB	9.88 oz. (280 g)



ISR-4 with ISR-SB Charging Base



ISR-AB Access Point Base
(sold separately)
Part #: 10-210839-24



ISR-2 Intelligent Surface Remote Control with WiFi and IR



Part #: 10-210838-23
 Included in the Box:
 ISR-2, ISR-SB charging
 base, power supply
 (5V, 2A)

Meet the ISR-2 Intelligent Surface Remote. Ideal for home entertainment, the ISR-2's 2.8" diagonal hi-resolution touchscreen offers intuitive swipe control on its customizable interface. With a full numeric keypad, it's perfectly suited for media control, enabling easy access to TV, movie channels, and streaming music. The ISR-2 combines sleek, modern styling with a practical layout, making it the remote you will also love for controlling lighting, climate, shades, security, and more.

Key Features

- Flush-mount, 2.8" capacitive LCD touchscreen (240x320).
- Wi-Fi control.
- Wi-Fi control and program updates.
- Accelerometer provides "instant-on" control.
- Thirty-two assignable/programmable keypad buttons for commonly used functions.
- 2 individually illuminated programmable capacitive buttons on the touchscreen.
- Cursor button allows simple scrolling list navigation.
- Extremely wide IR transmitting frequency range.
- Non-volatile Flash memory stores your system configuration even when power is not present.

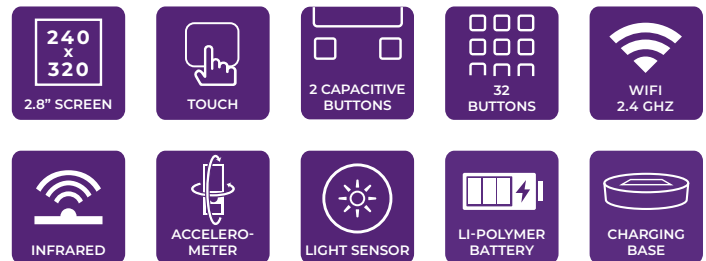

Specifications

Power	3.85 VDC, 1800 mAh Li-Polymer Battery Pack
Power Management	Integrated accelerometer
Infrared Control Range	30 feet (9.1 meters) @ 60 degrees
Infrared Frequency Transmission Range	15kHz - 460kHz
Radio Frequency Control Range	Up to 100 feet (30.5 meters)
Wireless Ethernet	802.11b/g/n @ 2.4Ghz
Touchscreen Display	High-brightness color IPS-TFT LCD.
.....	240 (RGB) x 320 pixels with 262k colors.
.....	Integrated high-resolution capacitive touchscreen
Display Size	2.8" (71mm) diagonal
Backlights	White LED (keypad & soft buttons)
Standby Time on Full Charge	7 Days
Battery Charge Time	3-4 Hours
Dimensions (L x W x D)	8.3" x 2.4" x 0.8"
.....	212 mm x 61 mm x 20 mm
Enclosure	Aluminum and molded ABS plastic
Weight ISR-2	7.48 oz. (212 g) with battery pack
Weight ISR-SB	9.88 oz. (280 g)



ISR-2 with ISR-SB Charging Base

ISR-AB Access Point Base
 (sold separately)
 Part #: 10-210839-24

ISR-AB Access Point Base for ISR Remotes

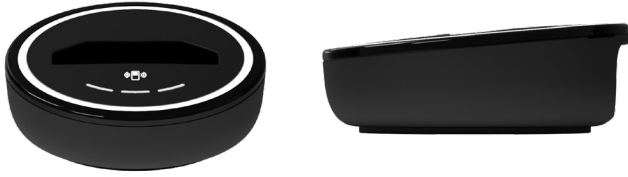

Part #: 10-210839-24

Included in the Box:

ISR-AB, international power supply (12V, 2A)

Specifications

Power Supply	+5VDC, 2.0A
Ethernet	10/100/1000BaseT, RJ-45 Connector
PoE.....	802.3af
Wi-Fi Frequency	2.4GHz
Wi-Fi Modes.....	802.11ac, n, g, b, and a
Wi-Fi Range.....	Minimum of 100ft (30m) indoors
Modes of Operation.....	Hard Wired Ethernet and Wi-Fi Bridge Mode
Security	WPA or WPA 2 password protection
Buttons.....	Four capacitive touch, all programmable through ID11
.....	One "Find my Remote" and three programmable scenes
Button LEDs.....	One programmable indicator of "Find my Remote" icon
.....	One programmable indicator for combined scene icons
Ring LED.....	Programmable to illuminate in one of many different colors
.....	Indications for charge, acknowledgments, & more
Power for ISR Remote.....	Charging for ISR-4 or ISR-2
Battery Charge Time	3-4 Hours
Minimum ID Version.....	11.12 or later

What if your remote's base did more than just charge? Introducing the ISR-AB Advanced Base—the first-ever charging base to offer programmable control buttons and a "Find My Remote" button, adding unmatched convenience and elevating the control experience. The ISR-AR Advanced Base is the perfect companion to your Intelligent Surface remote, providing an instant and dedicated Wi-Fi access point for seamless and uninterrupted control.

Equipped with three programmable soft keys, it's ideal for easy control of custom scenes or frequently used room functions—without even lifting the remote off the base.

Key Features

- Instant-Connect Wi-Fi Access. The ISR-AB creates a 2.4GHz Wi-Fi access point ensuring a fast, robust connection for the ISR remotes.
- Three programmable soft keys enable easy control for scenes and common events.
- Tap the Find-my-Remote button and the ISR Remote beeps an alert.
- Easy Charging ensures your Intelligent Surfaces Remote is always fully charged.
- Elegantly modern design.
- Adjustable Light Ring shows the charging status. Personalize both the color and the brightness.



T1-B+ Zigbee® Remote Control

Part #: 10-210503-12

Included in the Box:

T1-B+, docking station, power supply (5V, 2A), interchangeable keycap trees (2), wall mount bracket, screws and drywall anchors (2) for wall mount bracket



Specifications

Power	3.6 VDC, 950 mAh Lithium-Ion Battery Pack
Power Management	Automatic On/Off (tilt switch)
Infrared Control Range.....	30 feet (9.1 meters) @ 60 degrees
Infrared Frequency Transmission Range...	15kHz - 460kHz
Radio Frequency Control Range	Up to 100 feet
.....	(30.5 meters)
Radio Frequency Carrier.....	802.15.4 @ 2.4GHz (Zigbee®)
.....	& 433MHz
Backlight	White LED (Keypad)
Nominal Run Time on Full Charge	3 hours minimum,
.....	continuous use (7 days on average use)
Standby Time on Full Charge.....	30 Days
Battery Charge Time	3-4 Hours
Dimensions (L x W x D).....	10.0 in x 1.9 in x .9 in
.....	(254 mm x 48 mm x 23 mm)
Enclosure	High-impact molded ABS plastic
Weight.....	7 oz. (200 g) with battery pack

The T1-B+ is the third generation of RTI's popular T1 universal system controller, now featuring the RTI dual RF platform and backlit buttons. The T1-B+ allows all other factory remote controls to be combined into one simple, ergonomic user interface providing powerful one-handed system control. Featuring a sleek new industrial design and perfect assortment of keypad buttons for commonly used functions, the T1-B+ can operate today's sophisticated media system, no matter how complex, at an affordable price.

Key Features

- Dual RF transmission capability uses 433MHz and 2.4GHz (utilizing Zigbee® technology).
- Comfortable ergonomic design permits effortless, one-handed operation.
- Tilt switch can automatically turn on the backlight when picked up.
- 8 source and 4 general purpose assignable/programmable keypad buttons with interchangeable key labels - Laser Shark compatible.
- Ships with a certificate for one Laser Shark engraved button set.
- Supports "Companion Mode" (similar to SURFiR®) for use with the RTIPanel app.
- 40 assignable/programmable keypad buttons.
- Transmits IR and RF (or both -on a single button press!).

U3 Water Resistant Remote Control

Part #: 10-210739-23

Included in the Box:

U3, charging dock, cradle, mounting holster (2), lithium-ion battery (installed) (1), international power supply (5V, 1A) (1), size 10 mounting screws (4)

Specifications

Power 3.6 VDC, 900 mAh Lithium-Ion Battery Pack
 Radio Frequency Control Range Up to 100 feet
 (30.5 meters)
 Radio Frequency Carrier.....802.15.4 @ 2.4GHz (Zigbee®)
 & 433MHz
 Display..... Electronic Paper Display
 Display Size..... 1.9" (48mm) diagonal
 Battery Life2-3 Months on average use
 Battery Charge Time3-4 Hours
 Programming 2.4GHz Zigbee
 Dimensions (L x W x D)..... 7.9 in x 2.3 in x 1.1 in
 201 mm x 58 mm x 28 mm
 EnclosureHigh-impact molded ABS plastic
Removable rubber housing with anti-fungal coating
 IP Rating IP66: Dust tight and water repellent
 Weight 6.8 oz. (193 g) with battery pack



The U3 water-resistant remote is the perfect companion for hot tubs, pools, bathrooms, and decks, delivering exceptional control in environments too wet or harsh for standard remotes.

The U3 remote floats if dropped in water for easy retrieval. It uses inductive charging and wireless programming updates, allowing it to be completely sealed for exceptional (IP-66 rated) protection. The U3 combines the convenience and low power requirements of an electronic paper display with fully programmable soft-touch buttons for quick access to commonly used functions. The display is easy to read in bright light—even outdoors—and can be customized to each project via the award-winning RTI Integration Designer programming software.

Key Features

- Durable design is weather resistant.
- Completely sealed and floats.
- Dust tight and water repellent (IP66 rated).
- Dual RF capability uses 433MHz or 2.4GHz (utilizing Zigbee® technology).
- Sixteen programmable keypad buttons.
- 1.9" electronic paper display is easy to read in bright light.
- Three different screen text size selections.
- Inductive wireless charging.
- Rechargeable Lithium-Ion battery.
- Includes charging dock and weather resistant cradle.
- Includes wall mount holsters.

SURFiR Companion Remote Control

Part #: 10-210483-19

Included in the Box:

SURFiR, Alkaline AAA batteries (4), clear window, screwdriver, function label sheet, room label sheet

Specifications

Power 4 AAA Alkaline batteries
 Power Management Automatic On/Off
 Radio Frequency Control Range Up to 100 feet
 (30.5 meters)
 Radio Frequency Carrier.....802.15.4 @ 2.4Ghz (Zigbee®)
 & 433MHz
 Standby Time 365 Days
 Dimensions (L x W x D).....9.5" x 1.8" x 0.8"
 240 mm x 46 mm x 22 mm
 Enclosure High-impact molded ABS plastic
 Weight 8.0 oz. (228 g) with batteries



The SURFiR adds the convenience of hard buttons for tactile control to systems using Apple® or Android® devices as the main graphical interface. This eliminates the numerous screen swipes needed for control tasks that require frequent interaction such as channel changes, DVR control or volume adjustments. The SURFiR allows the user to enjoy the other benefits of their smart phone or tablet device: checking email, reading news feeds, accessing social media, etc. To further enhance the experience for the user, the SURFiR can track which electronic device is being controlled by the RTIPanel app and automatically controls the same. Powerful and intuitive control in an inexpensive package - everything you desire in a companion remote.

Key Features

- Provides a companion remote for use with the RTIPanel and Virtual Panel apps.
- Tracks page changes to stay in sync with one or more apps.
- Dual RF transmission capability uses 433MHz and 2.4GHz (utilizing Zigbee® technology).
- Remote finder beeper allows user to easily locate SURFiR by pressing a button on their smart phone or tablet.
- Completely customizable and programmable.
- Security screw on battery door for hotel applications.
- Inexpensive and requires no direct programming.
- Includes eight buttons that can be custom labeled.
- Works with any XP series control processor
- Battery low indicator.
- Uses 4 AAA batteries.

INTELLIGENT SURFACES™

TOUCHPANELS



IST-10 10" Intelligent Surface Touchpanel Black



IST-10-B (Black Touchpanel)

Part #: 10-210853-20

IST-10-W (White Touchpanel)

Part #: 10-210854-21

Included in the Box:

IST-10, metal wall bracket (1), mounting bracket screws (4), single gang low voltage mounting bracket (1)

Specifications

Power (Power Supply not included)	+12V DC, 2A or PoE (802.3af)
Power Management	Adjustable backlight/proximity sensor
Touchscreen Display	High-brightness 24-bit color IPS LCD WUXGA (1920x1200 pixels) with true black display filter
	Integrated high-resolution capacitive-touch screen
Display Size	10" (254 mm) diagonal, 16:10 aspect ratio
Display Backlight	LED Backlit, 400nit
Ethernet Port	RJ45, 10/100 Base-T with PoE
Camera	Color CMOS, 2MP, 15-30 fps at 1920x1080
Microphone	Built-in digital microphone array with Mute button, hardware-based echo cancellation
Speakers	Two (2), 8Ω, 1 Watt, 100-20KHz
Communications	Ethernet / Network IP WiFi 2.4G/5G 802.11a/b/g/n/ac
Mounting	Wall-Mount or Aluminum Table Stand (available separately as a kit including power supply)
Installation	US standard single or dual gang.
Outer Bezel Dimension (W x H x D)	9.39" x 6.24" x 0.43"
	238.5 mm x 158.5 mm x 10.9mm
Wall Cut-Out Dimension (W x H)	2.15" x 3.6"
	54.7mm x 91.5mm
Depth in Wall (Wall Box)	1.34" (34mm), leave space to account for the RJ-45 connector
Weight	14.1 oz (400g)

IST Stand Kit

Material	Silver anodized aluminum, black rubber feet
Dimensions (HxL)	5.25" x 5.25" (133.4mm x 133.4mm)
Dimensions (W)	Front: 5.27" (144.8mm), Rear 2.75" (69.9mm)
Weight	14.1 oz (400g)
Power Supply for IST-10	included

The IST-10 touchpanel elevates system control in all commercial and residential settings. It starts with a hi-resolution 10" capacitive-touch screen with a 1920x1200 resolution with true-black display filter for exceptional clarity. With an ultra-thin bezel and a near-flush mount (just 0.47"/ 12mm off the wall), the IST-10 makes an elegant statement in landscape or portrait mount, while the optional stand enables tabletop and countertop convenience. Built-in 10/100 Base-T Ethernet with PoE enables seamless two-way system control, video, and remote programming.

The hi-res display is ideal for the 100% customizable RTI user interface, with fast response and easy swiping. The proximity sensor enables a fast hands-free wake while the ambient light sensors automatically adjust display brightness. The IST-10 plays hi-resolution video in H.264 or H.265 format and is ideal for viewing security camera feeds. Dual speakers, far-field microphone array, SIP-readiness, plus full duplex capability make the IST-10 perfect for intercom and as an interface with video doorbells. The hi-res 2MP camera can double as a surveillance source, while its manual shutter ensures privacy. The 2-mic array features a mute button plus hardware-based echo cancellation.

Key Features

- Hi-resolution 10" capacitive-touch screen (1920x1200) with ultra-thin bezel.
- Near-flush mount (just 0.47"/ 12mm off the wall).
- Ethernet and Wi-Fi options for control and communication.
- PoE or 12V DC power options.
- Exceptional video streaming and two-way intercom at H.264 or H.265 format.
- Hi-res privacy ensured 2MP camera.
- Dual speakers and far-field microphone array (with mute button).
- Proximity and ambient light sensors.
- Tabletop stand option.
- Portrait or landscape with auto-rotate.



IST Stand Kit (Table Stand)
(sold separately)
Part #: 10-210856-23

IST-5 5" Intelligent Surface Touchpanel Black



The new IST-5 touchpanel elevates system control in all commercial and residential settings. It starts with a hi-resolution 5" capacitive-touch screen with a 854x480 resolution with true-black display filter for exceptional clarity. With an ultra-thin bezel, near-flush mount (just 0.47"/ 12mm off the wall), and elegantly compact form-factor, the IST-5 makes an elegant statement in landscape or portrait mount. Built-in 10/100 Base-T Ethernet with PoE enables seamless two-way system control, video, and remote programming.

The hi-res display is perfect for the 100% customizable RTI user interface, with fast response and easy swiping. The proximity sensor enables a fast hands-free wake while the ambient light sensors automatically adjust display brightness. The IST-5 plays hi-resolution video in H.264 or H.265 format and is ideal for viewing security camera feeds. Dual speakers, far-field microphone array, SIP-readiness, plus full duplex capability make the IST-5 perfect for intercom and as an interface with video doorbells. The 2-mic array features a mute button plus hardware-based echo cancellation.

Key Features

- Hi-resolution 5" capacitive-touch screen (854x480) with ultra-thin bezel.
- Near-flush mount (just 0.47"/ 12mm off the wall).
- Ethernet and Wi-Fi options for control and communication.
- PoE or 12V DC power options.
- Exceptional video streaming and two-way intercom at H.264 or H.265 format.
- Dual speakers and far-field microphone array (with mute button).
- Proximity and ambient light sensors.
- Portrait or landscape with auto-rotate.

IST-5-B (Black Touchpanel)

Part #: 10-210851-18

IST-5-W (White Touchpanel)

Part #: 10-210852-19

Included in the Box:

IST-5, metal wall bracket (1), mounting bracket screws (2), single gang low voltage mounting bracket (1)

Specifications

Power (Power Supply not included)	+12V DC, 2A or PoE (802.3af)
Power Management	Adjustable backlight/ proximity sensor
Touchscreen Display	High-brightness 24-bit color IPS LCD
	FWVGA (854x480 pixels) with true black display filter
	Integrated high-resolution capacitive-touch screen
Display Size	5" (127 mm) diagonal, 16:10 aspect ratio
Display Backlight	LED Backlit, 400nit
Ethernet Port	RJ45, 10/100 Base-T with PoE
Microphone	Built-in digital microphone array with Mute button, hardware-based echo cancellation
Speakers	Two (2), 8Ω, 1 Watt, 100-20KHz
Communications	Ethernet / Network IP
	WiFi 2.4G/5G 802.11a/b/g/n/ac
Mounting	Wall-Mount
Installation	US standard single gang
Outer Bezel Dimension (W x H x D)	5.24" x 3.33" x 0.43"
	133 mm x 84.5 mm x 10.9mm
Wall Cut-Out Dimension (W x H)	2.15" x 3.6"
	54.7mm x 91.5mm
Depth in Wall (Wall Box)	1.34" (34mm)
	leave space to account for the RJ-45 connector
Weight	7.05 oz (200g)

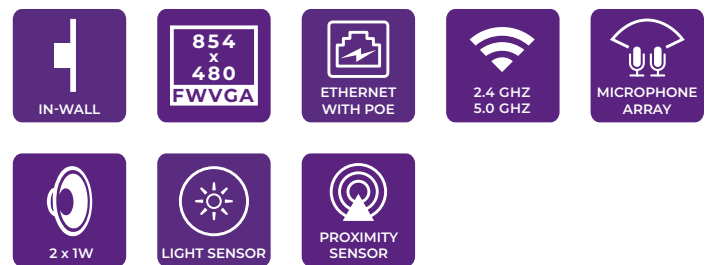

IST-10-FMK IST-10 Flush Mount Kit

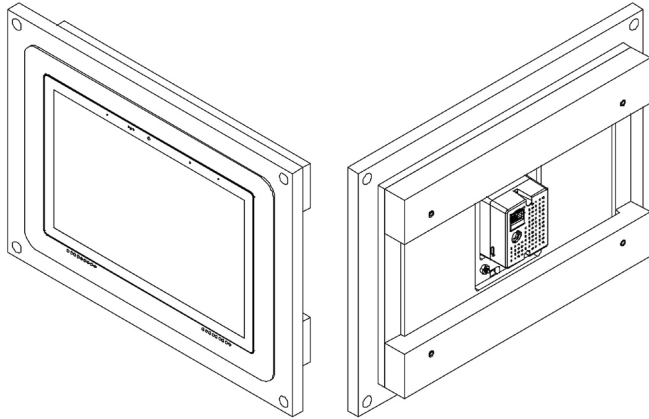

IST-5-FMK is an adapter for in-wall flush installation of an RTI IST-5 Touchpanel. IST-5-FMK firmly mounts the IST-5 touchpanel while allowing easy access, insertion and operation.

Key Features

- Flush with the wall.
- Paintable with the wall paint in any color and texture.
- Includes depth calibration mechanism.
- Allows easy insertion and removal of the touch screen.
- The adapter is supplied unpainted (To be painted after installation as part of the wall).
- Designed to be installed in ½" drywall.

Part #: 10-210880-20

Included in the Box:

IST-5-FMK Flush Mount Kit, M3x12 Flat screws (2), M3 nuts (2), Touchpanel adapter

Specifications

Material Moisture resistant MDF (compliant with TSCA Title VI)
 Installation ½" drywall
 Dimensions WxHxD 6.3" (160mm) / 8.3" (210.8mm) / 1.73" (44mm)
 Weight 1.32 lb (600g)

IST-5-FMK IST-5 Flush Mount Kit

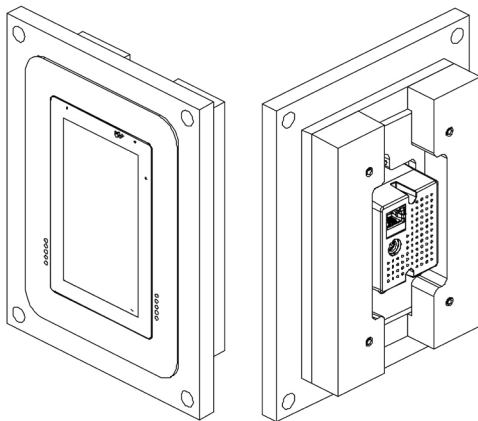

IST-10-FMK is an adapter for in-wall flush installation of an RTI IST-10 Touchpanel. IST-10-FMK firmly mounts the IST-10 touchpanel while allowing easy access, insertion and operation.

Key Features

- Flush with the wall.
- Paintable with the wall paint in any color and texture.
- Includes depth calibration mechanism.
- Allows easy insertion and removal of the touch screen.
- The adapter is supplied unpainted (To be painted after installation as part of the wall).
- Designed to be installed in ½" drywall.

Part #: 10-210879-28

Included in the Box:

IST-10-FMK Flush Mount Kit, M4x12 Flat screws (4), M4 nuts (4), Touchpanel adapter

Specifications

Material Moisture resistant MDF (compliant with TSCA Title VI)
 Installation ½" drywall
 Dimensions WxHxD 12.80" (325.1mm) / 9.45" (240mm) / 1.73" (44mm)
 Weight 1.54 lb (700g)

CX-7 7" Countertop/Under Cabinet Touchpanel



Screen Tilt - 90°



Screen Tilt - 10°

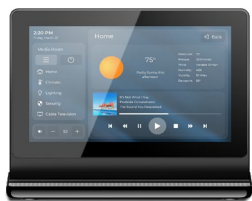

Tabletop Installation



Under Cabinet Mount (Inverted)

Part #: 10-210512-12

Included in the Box:

CX7, power supply (12V, 2A), rotatable RTI logo (1), mounting bracket (1), ferrite clamp

Specifications

Power	+9VDC to +16VDC, 1A max or PoE (802.3af)
Power Management	Adjustable backlight brightness/proximity sensor
Touchscreen Display	High-brightness color TFT LCD WVGA (800x480 pixels) with 65K colors
.....	Integrated high-resolution capacitive touchscreen
Display Size	7.0 in (177mm) diagonal
Display Backlight.....	Dual CCFL, 300nit
Infrared Output	Through control port, 200mA output Drives up to 1000 ft (300 m) of wire
Ethernet Port.....	10/100 Base-T with Power-over-Ethernet
Wireless Ethernet.....	802.11b/g
Video Input	Three, BNC Connectors
.....	Composite, S-Video or Component Analog Video
.....	NTSC/PAL/SECAM
Enclosure	High-impact molded ABS plastic
Mounting.....	Tabletop, or screws through mounting bracket (Included)
Dimensions (LxWxH)	7.5 in x 7.3 in x 6.25 in
.....	190 mm x 185 mm x 159 mm
Weight	2.0lbs (907g)

From the kitchen countertop to the conference room, the versatile CX7 is perfect wherever intuitive “always on” control is required. The 7” LCD touchpanel has adjustable tilt, allowing the display to be angled from straight up to nearly flat. The CX7 can be mounted inverted under a cabinet, ideal for kitchens. Additional features include wired and wireless Ethernet for two-way control, digital video (MJPEG), and web browsing. Analog audio/video inputs and stereo speakers allow video viewing sources, from security cameras to satellite TV. The integrated camera, microphone and speakers enable intercom support.

Key Features

- 800x480 WVGA LCD with integrated multi-touch capacitive touchscreen.
- Composite, S-video and component input for viewing video at 480i, 576i, 480p or 576p.
- Built-in camera, microphone and speakers enable intercom capability
- Integrated 10/100 Base-T and 802.11 Wireless Ethernet.
- Built-in high output IR port for direct control of devices through an IR connecting block.
- Powered using power supply or PoE (Power over Ethernet)
- Optional modules/processors provide advanced two-way control of electronics such as media servers, lighting, security and more!
- Adjustable tilt display (from 10°-90°) or CX7 can be mounted inverted under a cabinet.

TABLE TOP	7" 800x480	2-WAY	ETHERNET	PoE
WIFI 2.4 GHZ	CAM MIC SPEAKER	INFRA RED	VIDEO INPUT	AUDIO INPUT
PROXIMITY SENSOR	LIGHT SENSOR			

KX4 4" In-Wall Touchpanel Keypad w/ Control Processor



KX4 Touchpanel (White Bezel included)

Part #: 10-210811-14

BZB-KX4BL (Black Bezel)

Part #: 10-210834-19

BB-KX3/KX4 Backbox

Part #: 10-210560-15

Included in the KX4 Box:

KX4, white bezel, RJ45 to DB9 serial adapter (2), mounting wings (2), drywall template, screws (4)

Specifications

Power+12VDC to +16VDC, 1A max
 Power ManagementAdjustable backlight
 brightness/proximity sensor
 Touchscreen Display High-brightness color TFT LCD
 WVGA (480x800 pixels) with 16.7M colors
 Integrated high-resolution capacitive touch screen
 Display Size4.0 in (97.2 mm) diagonal
 Display Backlight.....LED Backlit, 310 nit
 Button Backlight..... Blue LEDs
 Infrared OutputOne, through control port, 200mA output
 Drives up to 1000 ft (300 m) of wire
 Serial Port Two, RJ-45, RS-232 communication
 Ethernet Port RJ-45, 10/100 Base-T with Power-over-Ethernet
 Relays Four, 2 Amps @ 30 VDC
 Sense Inputs Six, 2-24VDC
 RF Control Range Up to 100 ft (30.5m)
 RF Carrier 802.15.4 @ 2.4GHz (Zigbee®)
 Microphone Silicon MEMS
 Speaker One (1) 2 Watt, 8 Ohm
 Enclosure High-impact molded ABS plastic
 Front Plate High-impact molded ABS plastic
 Mounting... Integrated mounting wings, or screws through front plate
 Installation Cut-Out (W x H)2.942" x 5.192" (74.7 mm x 131.8 mm)
 Outer Bezel Dimension (W x H)..... 4.352" x 5.876"
 (110.5 mm x 149.25 mm)
 Total Depth in Wall 1.265" (32.1mm)
with mounting wings 1.624" (41.2mm)
 Additional room may be necessary depending on connections used
 Weight8.9 oz (252 g)

Ideal for single room commercial applications such as meeting rooms, classrooms, and lecture halls, the KX4 combines an in-wall touchpanel and hard button input with a built-in control processor. The result is an enhanced automation solution that combines control simplicity with power in a single cost-effective unit. For front panel control, the KX4 boasts a 4" high-resolution capacitive touch display with five configurable hard-buttons that can be customized with RTI's Laser Shark engraving.

The built-in control processor features advanced capabilities, including support for two-way drivers, RTiPanel App and expansion configurations. Back panel connections enable direct control of devices via IR, IP and two RS-232, six voltage sense ports with sense-event capabilities, and four relays for control via contact closure.

Key Features

- Vivid 4" WVGA (480x800) color capacitive touchscreen, and five hard buttons provide an incredibly simple and intuitive control experience.
- Built-in control processor features advanced capabilities including support for two-way drivers, RTiPanel App and expansion capabilities.
- Control processor also enables direct control of devices via IR, IP and two RS-232, six voltage sense ports with sense-event capabilities, four relays for control via contact closure and an astronomical clock for time-based events.
- Built-in 2.4GHz ZigBee® RF transceiver module and antenna enables wireless remote control support.
- Integrated 10/100 Base-T Ethernet (with PoE) for access to network security cameras, programming updates and more.
- Proximity sensor wakes up the unit as a user approaches and an ambient light sensor adjusts the touchpanel's backlighting.
- Powered using power supply, CB8 connecting block or PoE (Power over Ethernet).
- Stylish low-profile faceplate available in white or black (ships with white).



KP-2 / KP-4 / KP-8 2/4/8 Button In-Wall PoE Keypad Controller



KP-2 / KP-4 / KP-8 with Decora® style wall plate (not included)



KP-2 / KP-4 / KP-8 with black or white faceplate and keycaps (included)

KP-2 2-Button Keypad

Part #: 10-210523-14

KP-4 4-Button Keypad

Part #: 10-210849-25

KP-8 8-Button Keypad

Part #: 10-210850-17

Included in the KP Box:

KP-2, KP-4, or KP-8 in-wall keypad controller, black and white faceplates (2), black and white keycap sets (2), certificate for one Laser Shark engraved keycap set (1), captive screws (2)



Specifications

Power	PoE IEEE802.3af
Backlights.....	RGB LED - 16 programmable colors
Control Port.....	10/100 BaseT with Power over Ethernet
System Memory	512K Bytes Flash (non-volatile) memory
Macro Capability	Macro capability on every button
Communications.....	USB Type C programming port
Enclosure	Formed Steel, black powder coat
Front Plate	High-impact molded ABS plastic
Mounting.....	US standard single-gang box
Decora® Type Front Plate* Dimensions (H x W)	4.6" x 2.75"
.....	(117 mm x 70 mm)
Dimensions (H x W x D).....	4.1" x 1.8" x 1.7"
.....	104 mm x 46 mm x 43 mm
Installation Cut-Out (H x W)	2.8" x 1.8"
.....	71 mm x 46 mm
Total Depth in Wall	1.37" (34mm) plus Cables
Operating Temperature	+32°F to +122°F (0°C to +50°C)
Operating Humidity.....	5% to 95% Non-condensing
Weight	4 oz (113 g)

The KP keypad is the perfect addition to an RTI control system for fast and convenient control of music, lights, shades, and other devices or systems. Available with two, four, or eight fully programmable buttons, the KP keypad provides intuitive two-way feedback via configurable backlight colors for each button.

KP keypads ship with two sets of keypad faceplates and matching keycaps — one white and one black. For an elevated look and control experience, use RTI's Laser Shark® engraving service to personalize the keycaps with custom text and graphics. These are available in White and Satin Black.

Compatible with Decora® style wall plates and sized to fit in a single gang US box, the KP keypads seamlessly integrate into homes and commercial buildings with a clean, intuitive on-wall control solution to match any decor.

For installation convenience, KP keypads are PoE powered, using the same network cable that runs control communication with the RTI processor.

Key Features

- Two, four or eight assignable/programmable buttons.
- FREE Laser Engraving for custom text and graphics. A certificate for one free Laser Shark™ engraved keycap set included with purchase.
- Control communication and power over Ethernet (PoE).
- Ships with white keypad faceplate and keycap set, and a black keypad faceplate and keypad set.
- Backlight color is programmable on each button (16 colors available).
- Completely customizable and programmable.
- Fits in a single gang electrical outlet box.
- Network or USB Programming.
- Use any standard Decora® type wallplate (not included).

* Wallplate not included.

Decora® is a registered trademark of Leviton Manufacturing Co. Inc.

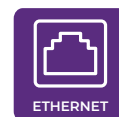

RKM-1+ In-Wall Audio Distribution Keypad

Part #: 10-210492-19

Included in the Box:

RKM-1+ (white), additional keypad cover, keycap set, mute & power buttons (1 each - black & light almond), window film (1 clear, 1 transparent purple), label sheet, screws (2)



RKM-1+ with Decora® style wall plate (not included)

Specifications

Power	+9VDC to +16VDC, 350mA max
Backlights	Blue LED - Eight sources
.....	Blue LED - Nine volume level indicators
Infrared Output Port.....	200mA output
.....	Drives up to 1000 ft (300 m) of wire
Enclosure	Formed Steel, black powder coat
Front Plate	High-impact molded ABS plastic -
.....	White, metallic gray or black
Mounting.....	Mounts into single-gang box
Wallplate Dimensions (H x W)	Purchased separately (Decora® Type)
Dimensions (H x W x D).....	4.1" x 1.8" x 1.0" (104 mm x 46 mm x 25 mm)
Installation Cut-Out (H x W)	2.8" x 1.8" (71mm x 46mm)
Total Depth in Wall	0.75 in (19mm) plus Cables
Weight	4 oz (113 g)

The RKM-1+ is a simple, intuitive keypad designed for multi-room audio control. Eight fully-programmable hard buttons and an open architecture provide the flexibility to control almost any multi-zone receiver or distributed audio system. The RKM-1+ incorporates a customizable LED backlit film which provides two-way feedback of power status, selected source, and volume level when used along with RTI XP processors and supported distributed audio systems. Sized for a single gang electrical box, the RKM-1+ is perfect for flush-mount installations in walls or cabinets and ships with white, black and light almond faceplate and buttons.

Key Features

- Provides feedback from multi-zone receivers via RTI XP control processors.
- Use any standard Decora® type wallplate*.
- Ships with white, black and light almond faceplate and buttons.
- Eight selectable sources.
- Backlit volume level indicator.
- Open architecture allows control of virtually any audio/video component.
- Non-volatile Flash memory stores your system configuration even when power is lost.
- IR output port drives up to 1000 feet of wire for standalone control.
- Fits in single gang electrical box.

* Wallplate not included.

Decora® is a registered trademark of Leviton Manufacturing Co. Inc.

Laser Shark® Custom Button Engraving

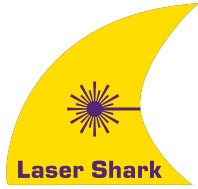

Laser Shark Paper Certificate
Part #: 10-210478-23
Laser Shark eCertificate
Part #: 10-210487-23

RTI Laser Shark® enables you to create custom button labels for compatible RTI products (listed below). The Laser Shark software allows you to use almost any font or graphic, to create custom engraved buttons.

Key Features

- Allows easy customization of button keycap labels on certain RTI products.
- Select the font type, language, symbol or graphic image.
- Compatible with KP-2, KP-4, KP-8, RK1+, RKM-1+, KX2, KX3, KX4, T1-B+.
- Certain touchpanel/keypad models have keycaps available in white and black (Light Almond not available).
- Software is free of charge and available to RTI dealers only.

Laser Shark Software

The Laser Shark® Software is available on the dealer section of the RTI website:
<https://www.rticontrol.com/dealer/software/custom-engraving>

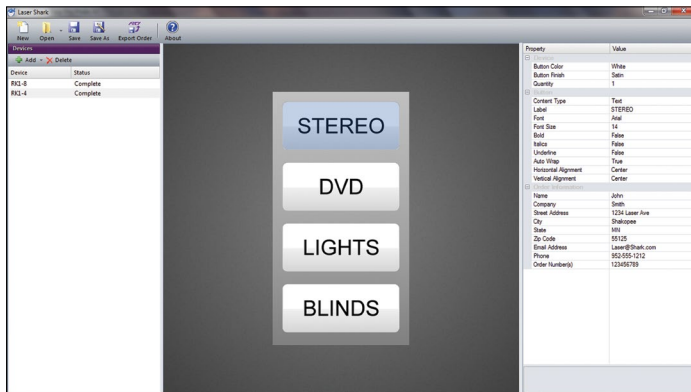

Laser Shark® Compatible Devices

RKM-1+
interchangeable source
indicator lens.



KP-2, KP-4, KP-8
all buttons

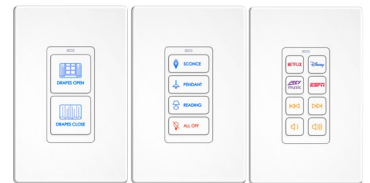

KX2
all twelve hard button
keycaps



KX4
all five hard button keycaps
(order includes 10 button
keycaps)

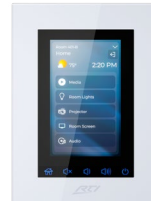

Instructions

<https://www.rticontrol.com/pub/media/wysiwyg/dealer/technote/RTI-Laser-Shark-Custom-Engraving-Quick-Tips.pdf>

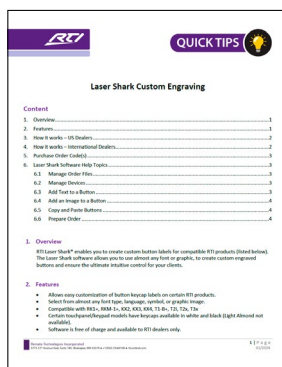

T1-B+
Eight "source" button
keycaps located at the top of
the T1-B.
Four "general purpose"
button keycaps below the
power button.



AUDIO DISTRIBUTION



AD-46-100 4x6 DSP Matrix Amplifier - 100W



Part #: 10-210841-17

Included in the Box:

AD-46-100, AD-46-100 faceplate, power cord, rack ears (2) with screws, 4-pin Phoenix connectors (4), feet with screws (4)

Specifications

Analog Sources.....	4 RCA (Stereo)
Digital Sources.....	2 Coax and 2 Optical (Mirror Analog 1 & 2)
Loop Out	4 Analog + 2 Digital
Amplified Zones	4 Stereo (8 Channels)
Preamp Zones	2 Stereo or 4 Mono (4 Channels)
Audio Zone Expansion	Up to 48 zones by combining
.....	up to 8 AD-46-100 units
Input Impedance.....	20kΩ
Amplifier.....	Class D
Power @ 8Ω.....	50W/Ch (all channels driven)
Power @ 4Ω.....	100W/Ch (all channels driven)
Power @ 8Ω Bridged	200W/Ch bridged (8Ω)
.....	(all channels driven)
THD-N	THD+N <0.01%, 1kHz @ 1/8 rated power
.....	THD+N <0.05%, 20Hz-20kHz @ 1/8 rated power
SNR	>95 dB, A-weighted input to output @ rated power @ Amp
.....	>100 dB, A-weighted - input to output @ preamp out
Frequency Response	20Hz - 20kHz +/- 2 dB @ 4Ω and 8Ω
Dynamic Range	>95dB A-weighted
Sampling Frequency.....	48kHz
RTI or 3rd Party Control	IP (RJ45), RS-232 (RJ45)
.....	and IR (3.5mm mono)
AC Input Voltage.....	100-120V/ 220-240V~, 50/60Hz, 800W
Power Switch	Front Panel On/Off with LED power indicator
Mounting.....	Rack mount or free-standing
Dimensions (W x H x D).....	17.2" x 16.4" x 3.5"
.....	437 mm x 416.5 mm x 89mm
Rack Units	2U
Weight	22.88 lb (10.38kg)

The AD-46-100 is a 4x6 DSP Matrix Amplifier for distribution of four audio sources to six zones, with four zones amplified at 100 Watts. Two zones feature preamp outputs to integrate external power amplifiers or subwoofers. The AD-46-100 enables seamless routing of both digital and analog sources to any desired zone and features a comprehensive set of DSP controls. Amplification is with an efficient Class D Cool Power® design that optimizes performance while minimizing heat generation.

Key Features

- Four analog audio source inputs and two mirrored digital inputs (mirrored analog inputs).
- Six stereo audio output zones with four amplified stereo and two preamp stereo outputs.
- Class D amplifier provides a robust and clear audio experience with 100 Watts @ 4Ω per channel per zone.
- Distribute four audio source inputs to six zones, expandable to 48 zones.
- Fine-tune acoustic characteristics for each zone with the 5-band parametric EQ, mixing and auto-ducking features.
- Configure and optimize DSP and matrix settings.
- Multiple control options with RS-232, IP and IR.
- Configure and optimize DSP and matrix settings directly within Integration Designer or with the intuitive web user interface.
- Rack mount or free-standing installation.

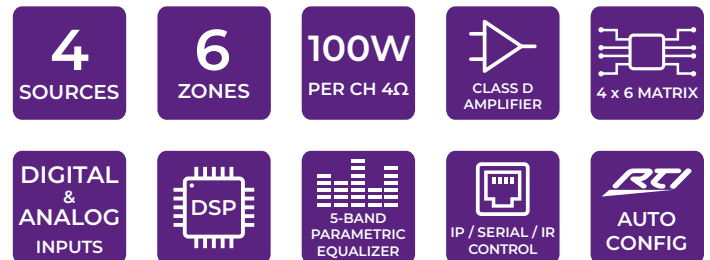

Analog and Digital Source Inputs

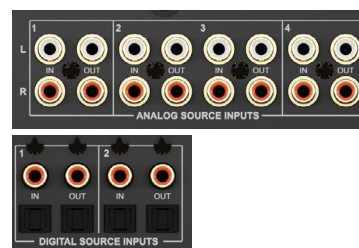

Preamp and Amplified Outputs

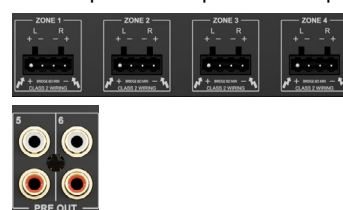

AD-810-100 8x10 DSP Matrix Amplifier - 100W



Part #: 10-210842-18

Included in the Box:

AD-810-100, AD81-100 faceplate, power cord, rack ears (2) with screws, 4-pin Phoenix connectors (8), feet with screws (4)

Specifications

Analog Sources..... 8 RCA (Stereo)
 Digital Sources..... 4 Coax and 4 Optical (Mirror Analog 1 - 4)
 Loop Out 8 Analog + 2 Digital
 Amplified Zones 8 Stereo (16 Channels)
 Preamp Zones 2 Stereo or 4 Mono (4 Channels)
 Audio Zone Expansion Up to 80 zones by combining
 up to 8 AD-810-100 units
 Input Impedance..... 20kΩ
 Amplifier..... Class D
 Power @ 8Ω..... 50W/Ch (all channels driven)
 Power @ 4Ω..... 100W/Ch (2 channels driven)
 75W/Ch (all channels driven)
 Power @ 8Ω Bridged 200W/Ch bridged (8Ω) (2 channels driven)
 150W/Ch bridged (8Ω) (all channels driven)
 THD+N THD+N <0.01%, 1kHz @ 1/8 rated power
 THD+N <0.05%, 20Hz-20kHz @ 1/8 rated power
 SNR >95 dB, A-weighted input to output @ rated power @ Amp
 >100 dB, A-weighted - input to output @ preamp out
 Frequency Response 20Hz - 20kHz +/- 2 dB @ 4Ω and 8Ω
 Dynamic Range >95dB A-weighted
 Sampling Frequency 48kHz
 RTI or 3rd Party Control IP (RJ45), RS-232 (RJ45)
 and IR (3.5mm mono)
 AC Input Voltage..... 100-120V/ 220-240V~, 50/60Hz, 1200W
 Power Switch Front Panel On/Off with LED power indicator
 Mounting..... Rack mount or free-standing
 Dimensions (WxHxD)..... 17.2"x16.4"x3.5" / 437 x 416.5 x 89mm
 Rack Units 2U
 Weight 23.77 lb (10.78kg)

The AD-810-100 is an 8x10 DSP Matrix Amplifier for distribution of eight stereo audio sources to ten zones, with eight zones amplified at 100 Watts. Two zones feature preamp outputs to integrate external power amplifiers or subwoofers. The AD-810-100 enables seamless routing of both digital and analog sources to any desired zone and features a comprehensive set of DSP controls. Amplification is with an efficient Class D Cool Power® design that optimizes performance while minimizing heat generation.

Key Features

- Eight analog audio source inputs and four mirrored digital inputs (mirrored analog inputs).
- Ten stereo audio output zones with eight amplified stereo and two preamp stereo outputs.
- Class D amplifier provides a robust and clear audio experience with 100 watts @ 4Ω per channel per zone.
- Distribute eight audio source inputs to ten zones, expandable to 80 zones.
- Fine-tune acoustic characteristics for each zone with the 5-band parametric EQ, mixing and auto-ducking features.
- Configure and optimize DSP and matrix settings.
- Multiple control options with RS-232, IP and IR.
- Configure and optimize DSP and matrix settings directly within Integration Designer or with the intuitive web user interface.
- Rack mount or free-standing installation.

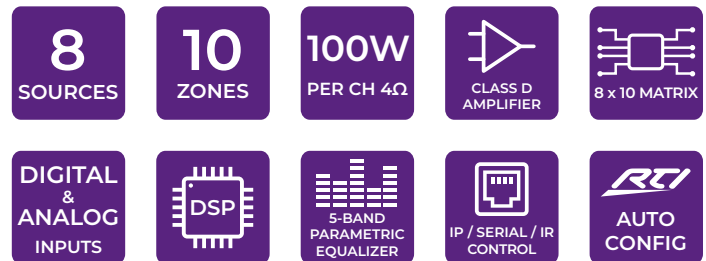

Analog and Digital Source Inputs

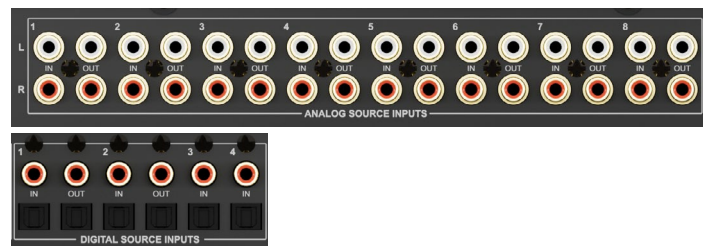

Preamp and Amplified Outputs

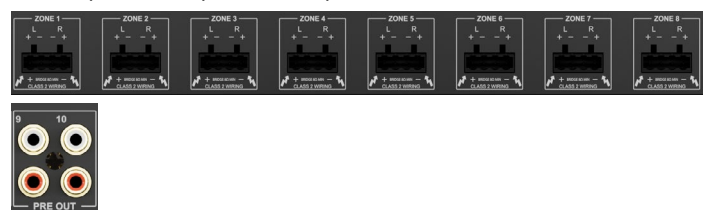

AD-1616 16x16 Audio Distribution DSP Matrix



Part #: 10-210843-19

Included in the Box:

AD-1616, AD-1616 faceplate, power cord, rack ears (2) with screws, feet with screws (4)

Specifications

Analog Sources.....	8 RCA (Stereo)
Digital Sources.....	8 Coax and 8 Optical
Loop Out	8 Analog + 2 Digital
Amplified Zones	Preamp only. Use a CP-16i for amplification
Preamp Zones	16 Stereo (32 Channels)
Audio Zone Expansion	Up to 64 zones by combining
.....	up to 4 AD-1616 units
Input Impedance.....	20kΩ
Analog Input	2 Vrms Maximum
Analog Output.....	2 Vrms Maximum. Volume controlled
Digital Optical Input.....	Up to 192kHz/24Bit sample rate
.....	PCM only
Digital Coaxial Input.....	Up to 192kHz/24Bit sample rate
.....	PCM only
THD-N	THD+N <0.01%, 1kHz
.....	THD+N <0.05%, 20Hz-20kHz
SNR	>100 dB, A-weighted - input to output @ pre out
Frequency Response	20Hz - 20kHz +/- 2 dB
Dynamic Range	>95dB A-weighted
Sampling Frequency.....	48kHz
RTI or 3rd Party Control	IP (RJ45), RS-232 (RJ45)
.....	and IR (3.5mm mono)
AC Input Voltage.....	100-240V~, 50/60Hz, 20W
Power Switch	Front Panel On/Off with LED power indicator
Mounting.....	Rack mount or free-standing
Dimensions (W x H x D).....	17.2" x 16.4" x 3.5"
.....	437 mm x 416.5 mm x 89mm
Rack Units	2U
Weight	18.12 lb (8.22kg)

The AD-1616 is a DSP Matrix for distribution of sixteen audio sources to sixteen zones. For projects that need more zones, up to four AD-1616 chassis can be combined to deliver 64 audio zones. The AD-1616 enables seamless routing of both digital and analog sources to any desired zone and features a comprehensive set of DSP controls.

For amplification, we recommend pairing the AD-1616 with the RTI CP-16i 16 Channel Cool Power® Amplifier. For projects that need more zones, up to four AD-1616 chassis can be combined to deliver 64 zones.

Key Features

- Sixteen audio sources inputs with eight analog inputs and eight digital inputs.
- Sixteen preamp stereo audio output zones to integrate external power amplifiers or subwoofers. Preamp outputs require external amplification via RTI CP-16i or third-party audio amplifier.
- Distribute sixteen audio source inputs to sixteen zones, expandable to 64 zones by stacking up to four AD-1616 units.
- Fine-tune acoustic characteristics for each zone with a comprehensive set of DSP controls such as 5-band parametric EQ as well as mixing and auto-ducking features.
- Configure and optimize DSP and matrix settings directly within Integration Designer or with the intuitive web user interface.
- Controlled via IR, and two-way control with feedback via RS-232 and IP when installed with RTI or 3rd party control systems.
- Rack mount or free-standing installation with included rack ears and removable feet.

16
SOURCES

16
ZONES

PRE
AMP

16 x 16 MATRIX

DIGITAL & ANALOG
INPUTS

DSP

5-BAND
PARAMETRIC
EQUALIZER

IP / SERIAL / IR
CONTROL

AUTO
CONFIG

2U
RACK
MOUNT

Analog and Digital Source Inputs

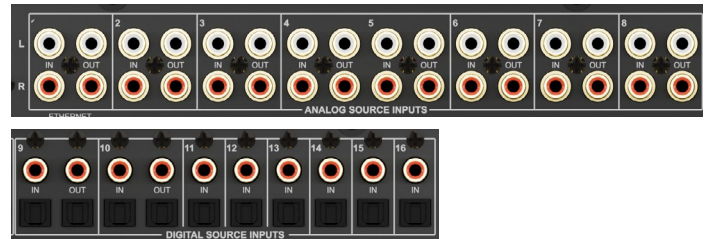

Preamp and Amplified Outputs



AMP-4-125 4 Channel 125W 8Ω, 2 Channel 70/100V 250W DSP Matrix Amplifier



Part #: 10-210860-18

Included in the Box:

AMP-4-125, power cord, 6-pin Phoenix input connectors (2), 4-pin Phoenix output connectors (2), 8-pin Phoenix GPIO socket connector (1), rack-mount kit (1), adhesive rubber feet (4)

Specifications

Analog Sources4 RCA (Unbalanced Stereo)
4 Phoenix Connector (Balanced Stereo)
 Digital Sources 1 Coax
 Amplified Zones..... 2 (4 Channels)
 Audio Zone Expansion... Daisy-chain multiple AD-4-125 units via Digital In/Out
 Output Power @ 4Ω / 8Ω4 x 125W
 Output Power @ 70V / 100V2 x 250W
 Output Voltage..... 45 Vrms (S,E), 70V/100V (Hi-Z)
 Power Share..... up to 2 x 250W (across each channel pair)
 Signal to Noise Ratio > 106 dB (A-weighted, 20 Hz – 20 kHz, 8Ω load)
 THD-N (typical)... < 0.05% (20 Hz – 20 kHz, 8Ω load, 3 dB below rated power)
 Frequency Response.....20 Hz – 20 kHz (+/- 0.5 dB, 8Ω load,
3 dB below rated power)
 Protection Circuits..... Short circuit, DC, Undervoltage,
 Temperature, and Overload protection
 RTI or 3rd Party Control.....IP (RJ45), GPIO (Phoenix Connector)
 AC Input Voltage.....100-240V~, 50/60Hz, 150W
 Mounting Rack mount or free-standing
 Dimensions (W x D x H)... 12.6" x 8.66" x 1.75" (320 mm x 220 mm x 44.5mm)
 Weight.....6.2 lb (2.8kg)

The AMP-4-125 power amplifier delivers configurable and reliable high performance audio power amplification for commercial and hospitality applications that demand a mix of low impedance and high impedance outputs.

With a compact 1U half-rack design, this DSP-enabled Class-D amplifier can drive low impedance 4Ω to 16Ω loudspeakers as well as high impedance 70V/100V transformer-coupled loudspeakers. The AMP-4-125 can accept four analog inputs and one stereo S/PDIF digital input, and delivers either two low impedance stereo outputs, or two 70V/100V mono outputs.

Key Features

- Four analog audio source input channels (balanced or unbalanced) and one digital input (S/PDIF).
- Two Lo-Z stereo or four Lo-Z mono output zones, two Hi-Z mono output zones, or a mix of each.
- Class D amplifier provides a robust and clear audio experience with 125 Watts per channel @ 4Ω/ 8Ω or 250W per channel @ 70Volts or 100Volts.
- Daisy-chain multiple amplifiers and expand the number of zones by by distributing up to two audio inputs or zones.
- Built-in DSP allows for fine-tuning acoustic characteristics for each zone.
- Easy configuration via LAN or WiFi.
- IP and GPIO control options.
- Free-standing installation or rack-mount (rack-mount kit included).

AMP-8-125 8 Channel 125W 8Ω, 4 Channel 70/100V 250W DSP Matrix Amplifier



Part #: 10-210861-19

Included in the Box:

AMP-8-125, power cord, 6-pin Phoenix input connectors (4), 4-pin Phoenix output connectors (4), 8-pin Phoenix GPIO socket connector (1), rack-mount kit (1), adhesive rubber feet (4)

Specifications

Analog Sources8 RCA (Unbalanced Stereo)
8 Phoenix Connector (Balanced Stereo)
 Digital Sources 1 Coax
 Amplified Zones..... 4 (8 Channels)
 Audio Zone Expansion... Daisy-chain multiple AD-8-125 units via Digital In/Out
 Output Power @ 4Ω/ 8Ω8 x 125W
 Output Power @ 70V/100V4 x 250W
 Output Voltage..... 45 Vrms (S,E), 70/100V (Hi-Z)
 Power Share..... up to 2 x 250W (across each channel pair)
 Signal to Noise Ratio > 106 dB (A-weighted, 20 Hz – 20 kHz, 8Ω load)
 THD-N (typical)... < 0.05% (20 Hz – 20 kHz, 8Ω load, 3 dB below rated power)
 Frequency Response.....20 Hz – 20 kHz (+/- 0.5 dB, 8Ω load,
3 dB below rated power)
 Protection Circuits..... Short circuit, DC, Undervoltage,
 Temperature, and Overload protection
 RTI or 3rd Party Control.....IP (RJ45), GPIO (Phoenix Connector)
 AC Input Voltage.....100-240V~, 50/60Hz, 300W
 Mounting Rack mount or free-standing
 Dimensions (W x D x H)... 17.35" x 12.6" x 1.75" (440mm x 320mm x 44.5mm)
 Weight.....8.4 lb (3.8kg)

The AMP-8-125 power amplifier delivers configurable and reliable high performance audio power amplification for commercial and hospitality applications that demand a mix of low impedance and high impedance outputs.

With a compact 1U design, this DSP-enabled Class-D amplifier can drive low impedance 4Ω to 16Ω loudspeakers as well as high impedance 70V/100V transformer-coupled loudspeakers. The AMP-8-125 can accept eight balanced or unbalanced analog inputs and one stereo S/PDIF digital input and delivers four low impedance stereo outputs at 125W per channel, or four 70V/100V mono outputs at 250W per channel.

Key Features

- Eight analog audio source input channels (balanced or unbalanced) and one digital input (S/PDIF).
- Four Lo-Z stereo or eight Lo-Z mono output zones, four Hi-Z mono output zones, or a mix of each.
- Class D amplifier provides a robust and clear audio experience with 125 Watts per channel @ 4Ω/ 8Ω or 250W per channel @ 70V/100V .
- Daisy-chain multiple amplifiers and expand the number of zones by by distributing up to two audio inputs or zones.
- Built-in DSP allows for fine-tuning acoustic characteristics for each zone.
- Easy configuration via LAN or WiFi.
- IP and GPIO control options.
- Free-standing installation or rack-mount (rack-mount kit included).

CM-232 RS-232 Communication Module



Part#: 20-210017-13

The CM-232 communication module provides an RS-232 interface to almost any RS-232 enabled device. It attaches to supported RTI control processors on one end, and a device's DB-9 serial port connector on the other end. The CM-232 is capable of one-way transmission (no receive function is supported) of user-defined character or binary strings.

Key Features

- Connects to the MPIO ports of RTI control processors (ex. XP-6s, XP-8v etc) and expansion modules (ex. PCM-4).
- Offers one-way RS-232 communication with nearly any RS-232 enabled device.
- Software-selectable baud rate up to 115.2K
- Industry-standard DB-9 male connector.
- No power supply required. Power is supplied by the output ports.
- User-definable output strings using Integration Designer® software.

Specifications

Baud Rate	Up to 115.2K. Software Selectable
.....(Depends on attached control system)	
Cable Length	12 Feet (3.7 m)
Connector	DB-9 Male
Pins Used	GND, TXD, DTR (tied high)
Dimensions (W x H x D)	1.3" x 0.5" x 2" / 33 x 14 x 51mm

CPB-1 Control Port Connecting Block



Part #: 10-210195-19

Included in the Box:
 CPB-1, power supply (12V, 1A), RJ45 to DB9 serial adapter

The CPB-1 Control Port Connecting Block provides a cost effective solution for installations such as classrooms or boardrooms that require a wired user interface and both infrared and RS-232 control of local devices. The CPB-1 provides power to one RTI wired user interface and has two output ports that allow the connection of up to two single or dual infrared emitters. It also incorporates an RS-232 port for control of devices without the need of an RTI processor.

Key Features

- Provides power for one compatible RTI wired user interface.
- RJ45 - DB9 adapter included.
- Two infrared emitter outputs.
- Variable IR output power.
- Allows RTI wired user interfaces to communicate via one-way RS-232 to devices without a processor.
- 12VDC power supply included.

Specifications

Power Supply	+12VDC, 1A
Number of IR Output Ports.....	Two
Output Ports	3.5mm jacks. Works with industry-standard IR emitters.
IR Output Drive	100mA maximum (per port, adjustable)
Infrared Input.....	Compatible with industry-standard repeaters and receivers
RS-232 Port.....	RJ45 Connection. Includes RJ45 to DB9 adapter
Mounting	Wall-mount or free standing
Dimensions (W x H x D)	4.0" x 3.5" x 1.1" / 102 x 89 x 28mm
Weight	8.4 oz. (238g)

ESC-2+ Ethernet to Serial Converter



Part #: 10-210554-18

Included in the Box:
 ESC-2+, power supply (5V, 2A), RJ45 to DB9 serial adapters (2), screws & drywall anchors (2).

The ESC-2+ Ethernet to Serial Converter provides a convenient way to add two RS-232 ports to an RTI XP series control processor. Wire the ESC-2+ to the local Ethernet network with standard cat-5 cable and it will offer full two-way control, as if the device was wired directly to the control processor. Two RJ45 jacks provide efficient cat-5 cabling between the ESC-2+ and the device being controlled.

Key Features

- Provides two additional serial ports to an RTI control processor.
- Use multiple ESC-2+ modules for virtually unlimited control of serial devices.
- Integrates seamlessly into Integration Designer.
- Can be discovered and configured by Integration Designer over Ethernet.
- Easy wiring to devices using cat-5 cable - Includes two RJ45 to serial adapters.
- A reset button allows the unit to be set back to default settings.

Specifications

Power Supply	+5VDC, 1A
Serial (RS-232) Ports.....	Two, RJ45
.....	Includes two RJ45 to DB9 adapters
Ethernet Port.....	One, RJ45, 10/100 Base-T
Enclosure	ABS plastic
Mounting	Wall-mount or free standing
Dimensions (W x H x D)	With Tabs 2.8" x 1.8" x 1.0" / 71 x 45 x 25mm
Weight	1.7 oz. (50g)

PCM-4 Ethernet Port Control Module



Part#: 10-210493-20
 Included in the Box:
 PCM-4, power supply
 (12V, 1A), USB cable
 (USB-A to micro-B)



Specifications

Power Supply +12VDC, 1A
 Multi-Purpose Output Ports Four custom 3.5mm 4-conductor jacks
 Designed for RTI modules as well as industry-standard IR emitters
 IR Output Drive 100mA maximum (per port, adjustable)
 Infrared Frequency Transmission Range..... 15kHz - 460kHz
 Infrared Input..... Compatible with industry-standard repeaters and receivers
 Ethernet Port..... One, RJ45, 10/100 Base-T with Power-over-Ethernet
 Trigger Output One, 12 VDC, 100mA max
 USB Port..... One, Programming
 Enclosure..... Formed steel, black powder coating
 Mounting Wall-mount or free standing
 Dimensions (W x H x D)..... 6.8in (173mm) x 2.9in (74mm) x 1.2in (31mm)
 Weight 14.3oz (406g)

With four multi-purpose I/O ports and a voltage trigger output (12VDC), the PCM-4 expands the output capabilities of an RTI XP series control processor to accommodate larger projects. Built-in Ethernet (with PoE) allows for convenient control over the local area network (LAN). Each MPIO port provides IR routing capabilities, one-way RS-232 communication* and power sensing.*

* With RTI accessory devices.

Key Features

- Four multi-purpose I/O ports made available to an RTI XP series control processor.
- Use multiple PCM-4 modules for virtually unlimited control of devices.
- Communication with XP processor over Ethernet network (LAN).
- Powered using power supply or class2 PoE (Power over Ethernet).
- Variable IR output power.
- 12VDC voltage trigger output.

RCM-4 Ethernet Relay Control Module



Part #: 10-210480-16
 Included in the Box:
 RCM-4, power supply
 (12V, 1A), terminal
 connectors (4), USB
 cable (USB-A to
 micro-B)



Specifications

Power Supply +12VDC, 1A
 Infrared Input..... Compatible with industry-standard repeaters and receivers
 Relays Four, capable of switching up to 28VDC@5A
 Ethernet Port..... One, RJ45, 10/100 Base-T with Power-over-Ethernet
 USB Port..... One, Programming
 Mounting Wall-mount or free standing
 Dimensions (W x H x D)..... 6.8in(173mm) x 2.9in(74mm) x 1.2in(31mm)
 Weight 1.0 lb. (466g)

The RCM-4 is equipped with four individually addressable relays. Built-in Ethernet enables the convenience of control from an RTI XP series control processor via the LAN. An IR input allows the RCM-4 to be triggered from many different sources, including RTI wired user interfaces, control processors or third-party infrared repeater systems. Commands trigger open and close functions as well as adjustable hold times for momentary relay operation. The RCM-4 can be powered from the included power supply or PoE.

Key Features

- Four individually addressable relays.
- Relays capable of switching up to 28VDC@5A.
- Relays can be used in a normally open or normally closed configuration.
- Relays can be controlled with both IR and Ethernet.
- Powered using power supply or class2 PoE (Power over Ethernet).

VPS-1 Voltage Sensor Module



Part #: 20-210015-11

Specifications

Output..... Compatible with industry standard IR emitters
 IR Output Drive 100mA maximum
 Input Requirements..... 3V to 24VDC -or- 9V to 30V P-P AC (50Hz min)
 Maximum Current Consumption..... 0.5mA
 Control Cable Length 12 feet (3.7 m)
 Voltage Sensor Cable Length..... 3 feet (.9 m)
 Dimensions (W x H x D)..... 1.75" (44mm) x 3.0" (76mm) x 0.7" (18mm)

The VPS-1 Voltage Power Sensor monitors the on and off status of almost any electronic component and provides this power status information to RTI control systems such as the XP-6s control processor. When the attached component is powered on, the VPS-1 detects the voltage supplied from the component, an attached power supply, or a third-party power sensor, and sends a signal to the RTI control system.

Key Features

- Connects to the MPIO ports of RTI control processors (ex. XP-6s, XP-8v etc) and expansion modules (ex. PCM-4).
- Detects the on/off status of almost any component.
- No power supply required - Power is supplied by the output ports.
- Power sensing circuit is housed in a compact, rugged ABS enclosure.
- LED light indicates the current power status.
- Control cable can be extended up to 500 feet.

ECB-5 IR Emitter Connecting Block



Part#: 10-210076-17

The ECB-5 IR Emitter Connecting Block provides expanded infrared signal distribution when used with RTI control processors, wired user interfaces, third party infrared repeater systems, etc. It has one infrared signal input and five emitter output ports that allow the connection of up to five single or dual infrared emitters.

Key Features

- Five infrared emitter outputs.
- Incorporates a sense input for monitoring the power status of a switched outlet, current sensor, light sensor, etc.
- Variable IR output power.
- Steel construction.
- No power supply required for operation.

Specifications

Power Supply (not included).....	+9VDC to +16VDC, 1.5A
Number of Output Ports	Five
Output Ports	3.5mm jacks
.....	Works with industry-standard IR emitters.
IR Output Drive	100mA maximum (per port, adjustable)
Infrared Input.....	Compatible with industry-standard repeaters and receivers
Mounting	Wall-mount or free standing
Dimensions (W x H x D)	2.6" (66mm) x 2.4" (61mm) x .9" (23mm)
Weight	4 oz. (108g)

IPE-4 IR Port Expander



Part #: 10-210479-24
Included in the Box:
 IPE-4, mini jack cable (3ft), screws & drywall anchors (4)

The IPE-4 IR Port Expander provides convenient infrared signal expansion when used with RTI control processors. It has one 3.5mm infrared signal input jack and four IR emitter output ports that allow the connection of up to four single or dual infrared emitters. No additional power supply is required.

Key Features

- Allows easy expansion of up to four emitters to a control processor IR port.
- Compatible with most industry standard single or dual IR emitters.
- Sturdy steel construction.
- A power supply is not required for the IPE-4 to function.
- A 3'(1m) mono cable with 3.5mm mini-plugs is included for easy connection to RTI processors.

Specifications

Number of Output Ports	Four
Output Ports	3.5mm jacks
.....	Works with industry-standard IR emitters.
IR Output Drive	100mA maximum (per port)
Infrared Input.....	3.5mm jack
.....	Compatible with RTI processors, industry-standard repeaters and receivers
Mounting	Wall-mount or free standing
Dimensions (W x H x D).....	With tabs 5.1"(130mm) x 1.9"(48mm) x .9"(23mm)
Weight	6.8 oz. (192g)

vIRsa Mouse IR Emitter



Part #: 10-210268-20
Included in the Box:
 vIRsa Mouse, tie wrap, clear holder, dark red holder

Designed with the professional integrator in mind, the "versatile" vIRsa Mouse is an IR emitter built to outperform all others. It is loaded with features to make installations go smoother, such as an unobtrusive, low-profile design, a flexible film adhesive and a separate holder that allows easy removal/replacement of the emitter. vIRsa Mouse is engineered with an actual (translucent) PCB to improve the integrity of electrical connections, a built-in resistor protects against over-driving and precision molding ensures consistent quality.

Key Features

- Sleek, low-profile and symmetrical design.
- Separate holder allows for easy removal and replacement of emitter.
- Includes two emitter holders (one red, one clear).
- Blue LED flasher can be visible or covered.
- 10' cable reaches the entire rack - includes cable management strap.
- Flexible film adhesive conforms to curved surfaces.
- Translucent circuit board.
- Industry standard 3.5mm mini-plug uses precision over-molding.

Specifications

Output.....	Compatible with industry standard IR repeater systems
Infrared Power Requirements.....	12VDC, 100mA maximum
Maximum Current Consumption.....	30mA
Cable Length	10 feet (3.0 m)
Plug type	3.5mm
Dimensions (W x H x D)	0.4" (10mm) x 0.5" (13mm) x 0.1" (2.5mm)

ZM-24 Zigbee® Transceiver Module



Part#: 10-210178-20
Included in the Box:
 ZM-24, power supply (12V, 1A), Installation bracket, drywall screws/anchors (2), antenna, CAT5e RJ45 cable (6ft)

The ZM-24 2.4GHz Zigbee® Transceiver Module provides bi-directional communication between two-way enabled RTI remote controls and control processors utilizing Zigbee® wireless communication. Capable of being hard-wired directly to a control processor or be used as a wireless repeater device to create an ultra-reliable, self-healing Zigbee® network. The ZM-24 does not directly control A/V components. It must be used in conjunction with a Zigbee® enabled processor.

Specifications

Power +9VDC to +16VDC, 60mA
 RTI Com Port Two-way Zigbee® Communication Port, RJ45 Connection
 Drives up to 1000 ft (300 m) of wire
 Wireless Networking IEEE802.15.4 Zigbee® network compliant
 RF Frequency Range 2.4Ghz - 2.5Ghz
 Communications OTA (Over-the-air) Programmable
 Enclosure High-impact molded ABS plastic, black
 Mounting Detachable bracket
 Dimensions -Ant. Flat (WxHxD) 3.5" (89mm) x 4.0" (101mm) x 1.1" (28mm)
 Dimensions -Ant. Ext. (WxHxD) .. 3.5" (89mm) x 7.25" (184mm) x 1.1" (28mm)
 Weight 4 oz (113g)

Key Features

- Enables bi-directional wireless communication.
- Wireless communication range between ZM-24 modules up to 100 ft.
- Connects to a processor up to 1000 feet away via standard Cat-5 cable.
- Can be used in "coordinator" mode, or create a Zigbee network by adding modules configured in "repeater" mode.
- Utilizes IEEE802.15.4 wireless Zigbee® communication at 2.4Ghz.
- Easy mounting with adjustable antenna and detachable wall bracket.
- Powered by an RTI control processor or included power supply.

ZW-9 Z-Wave® Interface Module (EU & AU Model only)



Part #:
EU Model: 10-210552-16
AU Model: 10-210553-17
Included in the Box:
 ZW-9, power supply (5V, 2A), mounting plate, screws & drywall anchors (2)

The ZW-9 Z-Wave interface uses the Z-Wave wireless protocol to provide the communication link between RTI systems and lighting, door locks, thermostats, and other Z-Wave-enabled devices. Eliminating the need for a different app for each device, the ZW-9 combined with an RTI XP central processor provides users with unified control and monitoring over all devices directly on their RTI user interface.

Specifications

Power Supply +5VDC, 2A
 RTI Communication RJ45, Ethernet
 Wireless Networking Z-Wave Plus Network Compliant
 RF Frequency Range Varies by region
 Enclosure High-impact molded ABS plastic, black
 Mounting Detachable bracket
 Dimensions (W x H x D) 5.167" (131mm) x 4.0" (102mm) x 1.12" (28mm)
 Weight 4.1 oz. (116g)

Key Features

- Wireless control and monitoring of Z-Wave devices via the RTI control system.
- Certified as a Z-Wave Plus product.
- Compatible with a broad range of Z-Wave certified electronics
- Expandable and scalable system allows control of more than 200 devices.
- Programmed using RTI Integration Designer software.
- Powered via PoE (Power over Ethernet) or included power supply.

RM-433 RF Receiver



Part #: 10-210039-16
Included in the Box:
 RM-433, antenna, 3-conductor wire

The RM-433 is a radio frequency receiving device for communicating to RTI control systems and operates at 433MHz. The RM-433 contains a microprocessor that monitors all received signals so that RF noise is filtered out. When valid RF data from an RTI remote is detected, the RM-433 passes the signal through its output driver which allows the data to travel long distances over wire. The output driver is compatible with industry standard infrared repeating systems, and can be wired together with those systems or with additional RM-433 units.

Specifications

Power Requirements +9VDC to +16VDC @ 60mA
 RF Carrier Frequency 433.92 MHz
 Output Drive 200mA maximum
 Module Dimensions (HxWxD) .. 3.5in (89mm) x 3.4in (86mm) x 1.0in (25mm)
 Antenna Length 13 in" (330mm)
 Weight 4.4 oz. (125 grams)

Key Features

- Reliable RF reception due to matched antenna, connector, and PCB.
- Modular design that allows multiple RM-433 units to be wired together allowing for nearly any desired coverage area.
- Output signal is compatible with industry standard infrared repeating systems. This allows multiple IR and/or RF receivers to be wired together into an RTI control system.
- No dedicated power supply required. Power is derived directly from the RTI control system.
- A feedback LED confirms operation.

CB-8 Connecting Block



Part #: 10-210205-11
Included in the Box:
 CB-8, power supply
 (16V, 4.3A)

The CB-8 is an installation accessory designed to provide convenient and reliable power connections for up to eight (8) RTI in-wall keypads, touchpanels and other devices. In addition to providing power, the CB-8 combines and routes the infrared outputs from the touchpanels to a single output for connection to an RTI control processor. Multiple CB-8 units can be daisy-chained for connecting more than eight devices. A 4.3 Amp, 16VDC power supply is included.

Specifications

Power	+16VDC, 4.3A
Maximum Current per Port	1.5A
Enclosure	Formed steel, black powder coating
Dimensions (H x W)	5.5 in (127mm) x 9.4 in (239mm)
Mounting	Wall-mount or free standing
Weight	12.6oz (359g)

Key Features

- Includes 16VDC, 4.3 Amp power supply capable of powering up to eight RTI wired user interfaces.*
- Multiple CB-8 units can be daisy-chained.
- Standard RJ45 ports for easy connection of touchpanels

PS16-1 16VDC Power Supply



Part #: 40-210285-22

The PS16-1 is used to power a single in-wall touchpanel, when a connecting block (CB-8) is not used.

Specifications

Power Supplied	+16 VDC, 1.6A, 25W
Dimensions (L x W x H)	3.7 in (94mm) x 2.2 in (56) x 1.3 in (34mm)
Weight	10.0oz (290g)

NOTE: Actual design/specs may vary.

IST Power Supply



Part #: 20-210403-12
Included in the Box:
 power supply (1) with
 US, EU, UK, AU plugs

The IST Power Supply is used to power either the IST-10 or IST-5 touchpanel when PoE is not used.

Note: The IST Power Supply is included in the IST Stand Kit

Specifications

Power Supplied	+12VDC, 2A
Dimensions (W x H x D)	2.75 in (70mm) x 1.625 in (41) x 1.5 in (38mm)
Weight	5.7oz (161.6g)



ZB-PRO Professional 2.4GHz Zigbee® Network Management Tool



Part #: 10-210216-13
 Included in the Box:
 ZB-PRO, USB extension
 cable

The ZB-Pro is a Professional Network Management Tool for use with RTI 2.4GHz wireless ZigBee® networks. Attached to a standard USB port of a PC, the ZB-Pro communicates with ZM-24 Transceiver Modules via 2.4GHz RF during the setup process.

Key Features

- Updates the firmware in the RTI ZM-24 Transceiver Module.
- Downloads network configuration data into a ZM-24.
- No external power supply is required. Power is derived directly from the USB port.
- Utilizes IEEE 802.15.4 wireless Zigbee® communication at 2.4Ghz.
- Feedback LEDs confirm various operations.
- Compact, rugged design.
- Available only to professional systems integrators

Specifications

Power Requirements Powered directly from USB port
 RF Carrier Frequency 2.4GHz (Zigbee® technology)
 Standards IEEE 802.15.4 (Zigbee® Wireless Mesh Networking)
 Dimensions (HxWxD)..... 4.28" (109mm) x 1.37" (35mm) x .65" (17mm)
 Weight 1.1 oz (32 g)

ZW-PRO Z-Wave® Network Management Tool



Part #: 10-210606-16

The ZW-PRO is a Professional Network Management Tool for use with Z-Wave wireless networks. Attached to a standard USB port of a laptop computer, the ZW-PRO wirelessly communicates with Z-Wave enabled devices during the network inclusion setup process. Used in conjunction with the Z-Wave Manager configuration software, the ZW-PRO simplifies the Z-Wave network setup, by allowing the installer to roam the installation with a laptop as they move between device locations.

Key Features

- Enables “inclusion” of devices onto Z-Wave wireless network.
- Plugs into a laptop USB port allowing the installer to roam to each device during Z-Wave network setup process.
- Designed to aid Z-Wave network setup for devices such as door locks and security devices with a short wireless range before “inclusion”.
- No external power supply is required. Power is derived directly from the USB port.
- Compact, rugged design.
- Available only to professional systems integrator.

Specifications

Power Requirements Powered directly from a PC USB port
 Wireless Networking Z-Wave Plus Network Compliant
 RF Frequency Range 908.4MHz (US Region)
 Varies by region
 Dimensions (LxWxD)..... 3.46" (88mm) x 1.1" (28mm) x .39" (10mm)
 Weight5 oz (14 g)



AVPro Global Holdings, LLC
2222 E 52nd Street N
Sioux Falls, SD 57104
www.rticontrol.com

